

Spray dryer
Spray cooler



Company overview

Trade name	: PRECI Co., Ltd.
Trademark	:  PRECI
Established	: August 1, 2005
Capital	: 30,000,000 JPY
CEO	: Hayato Kato
Products & services	: Powder technology Spray dryer, Spray cooler, Freeze granulator Biotechnology Shaker, Incubator shaker, Platelet shaker, High-pressure steam sterilizer High precision cleaning technology High precision cleaning system, Condenser, Dehydrator, Liquid regenerator, Vacuum dryer, Water purifier Test, Analytical measurement and Consignment processing Powder production process, High precision cleaning process
Company motto	: 以和為貴(Wa wo motte totoishi to nasu) This famous quote by seventh-century Japanese statesman Prince Shotoku means "Harmony is to be valued".
Corporate philosophy	: "Inspire and realize the value that truly makes people happy, and bring it to reality. By doing so, we contribute to the development of society as a whole."
Affiliated groups	: The Association of Powder Process Industry and Engineering, Japan (APPIE) Japan Scientific Instruments Association (JSIA) Japan Industrial Conference on Cleaning (JICC)

Page	Contents
01	Company overview
02	Spray drying
06	R&D Lab spray dryer, Spray boy
07	Small-scale spray dryer, R-Series
08	Turning spray dryer, TR-Series
09	Pilot-scale spray dryer, P-Series
10	Production-scale spray dryer, D-Series
11	Spray cooler
12	Testing and Consignment processing
14	Rental service

Spray drying

Spray drying, which produces a dry powder from a liquid or slurry, is one of the most popularly-used continuous drying processes. A liquid including solutions, emulsions, wet slurry and suspensions is sprayed via a spray nozzle or a rotary atomizer into a drying chamber. Continuously feeding heated gas while increasing the surface area of sprayed droplets rapidly dries and makes granules. Therefore, degeneration of the powder is exceptionally low and the process can be the preferred process of thermally sensitive materials. Dried granules are highly close to spherical in shape and have excellent fluidity. For foods and pharmaceuticals, they will be easily soluble in water. For inorganic materials such as metallurgical powders and fine ceramics, high-density molds can be obtained.

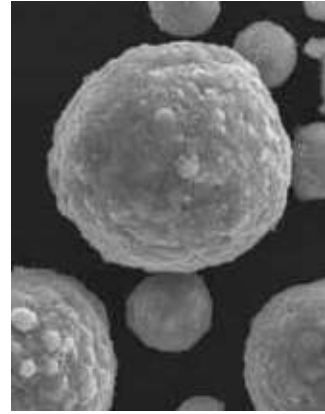

The process of spray drying produces stable spherical granules and a sharp particle distribution.



Aluminum oxide



Oligosaccharide

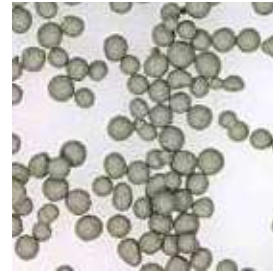

Silicon carbide

Applicable fields

Spray dryers are used in a variety of industries. Below are some of the fields that we have been involved with.

Food	Collagen, Chitosan, Agaricus, Propolis, Herbal medicine extracts, Lactobacillus, Green tea extracts, Vitamin C, Stevia, Inulin, Dextrin, Glucose, Flavors, Dairy products, Seasoning, Algae, Albumen, Fishery products
Chemicals and Pharmaceuticals	Polymers, Pigments, Yeast, Enzymes, Biopharmaceuticals, Medical products, Agricultural chemicals, Dental materials, Surfactants, Antibiotics, Cosmetics
Industrial materials	Zeolite, Catalysts, Glass materials, Fire-resistant materials, Cellulose, Pulp, Carbon materials, Superconducting materials, Fine ceramics, Toners, Abrasives, Piezoelectric ceramics, Semiconductor materials, Magnetic materials, Optical fiber materials, Battery materials
Steel and Metals	Rare metals, Alloys, Rare earth materials

Process design

The capacity of spray dryers is generally measured by water evaporation volume. However, we believe that the most important aspect is to target both powder formation and production efficiency. Even if two spray dryers have the same water evaporation capacity, the process design will differ depending on the material characteristics and operating conditions. Our engineering specialists provide spray dryers that exactly match your needs by carrying out unique testing, evaluation, and process designing for each project based on our expertise and technical knowhow accumulated over many years. We also take environmental and safety requirements seriously. In order to save energy, our unique heat exchanging process allows you to reduce both CO₂ and energy costs. Our technologists also design the most suited process to meet your strict safety requirements and legal regulations.

Process flows

Open-cycle system

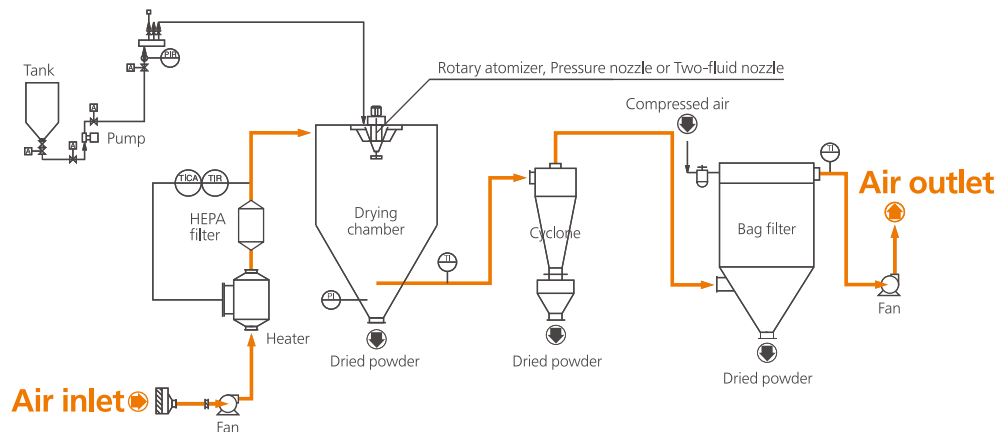

Closed-cycle system

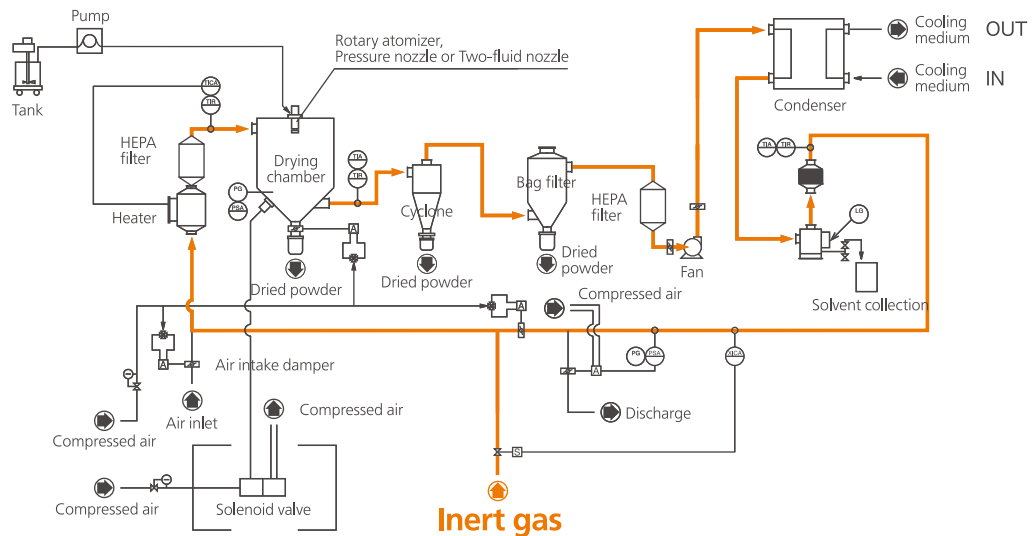

For water solvents, an open-cycle system (where atmospheric air is used) is generally selected. For flammable solvents as well as oxygen-sensitive materials, a closed-cycle system (where an inert gas, e.g., nitrogen, is used) is normally selected. If required, an open cycle system for flammable organic solvents such as ethanol can be selected. As a safety measure, the spray dryer is controlled at below 25% of the lower explosion limit of the gas concentration. The evaporated solvent is discharged after the catalyst or the heating decomposition process.

Atomization modes

Rotary atomizer

Our specially designed rotary atomizers are suited for the particle size range of 20 - 200 μ m. The particle size can be controlled by disc shapes and rotating speed. Compared to other atomization modes, a rotary atomizer is able to create granules with a sharp particle size distribution and high fluidity.



Rotary atomizer

As our design principle, a motor direct link system is applied as a standard feature in order to obtain a long lifespan and easy maintenance. Currently, we are carrying out various technical developments such as the use of non-contact seal, reduction of mechanical noise, and further simplification of maintenance.



Disc

We have developed our unique disc design in order to reduce the rotational speed even if the same particle size is targeted. It allows for a lifetime much longer than high speed rotating atomizers. A variety of materials such as stainless steel, fine ceramics and coated materials are also available.



Model	PR-015K	PR-10K	PR-15K	PR-22K	PR-37K	PR-55K
Rotational speed	20000rpm	20000rpm	20000rpm	12000rpm	12000rpm	12000rpm
Capacity	~10kg/h	~100kg/h	~150kg/h	~300kg/h	~600kg/h	~1000kg/h
Power	0.15kW	1.0kW	1.5kW	2.2kW	3.7kW	5.5kW

Model	PR-005-D	PR-005-B	PR-015D	PR-015-B	PR-075-B	PR-250-B
Rotational speed	30000rpm	30000rpm	30000rpm	24000rpm	18000rpm	18000rpm
Capacity	~500kg/h	~500kg/h	~1500kg/h	~1500kg/h	~7500kg/h	~25000kg/h
Power	5.0kW	5.0kW	15.0kW	15.0kW	75.0kW	250.0kW

*D: Motor direct drive model B: Belt drive model

Nozzles

The most appropriate nozzle can be selected depending on the liquid's characteristics and operating conditions. A variety of materials such as stainless steel, fine ceramics, special alloys and coated materials are available.



Two-fluid nozzle

Two-fluid nozzle atomization is suited for granules below the particle size of 20 μ m. One fluid is the liquid to dry and the other one is compressed gas to impact the liquid to be atomized. By controlling the liquid concentration, viscosity and gas-liquid ratio, it is possible to target single-micron particles. Our own unique nozzle is specially designed to prevent clogging even for high-concentration and high-viscosity fluids.



Single-fluid nozzle (Pressure nozzle)

A single-fluid nozzle atomizes by the kinetic energy of the liquid pressure. As the pressure increases, the flow through the nozzle increases, and the size of droplets decreases. A variety of nozzle orifices can be selected to meet suitable material properties and operating conditions. By creating the condition of universal-joint nozzles, a smaller drying chamber can be designed in situations of a limited footprint.



Powder collections

Dual collection method

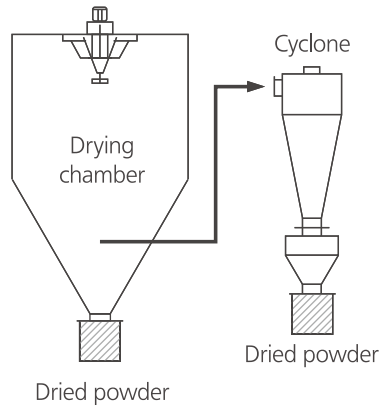

The powder is collected at two points: beneath the drying chamber and the cyclone. Spherical powder with good fluidity can be collected from the drying chamber and fines are collected from the cyclone. This method therefore can be beneficial for grading the powder.

Cyclone collection method

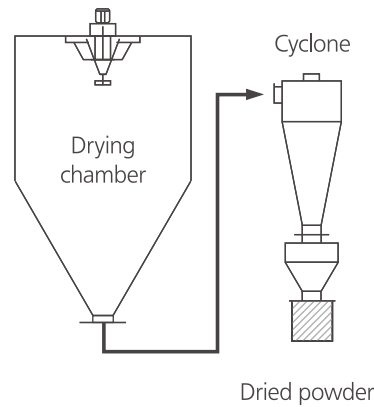

A cyclone separates particles from the gas stream by its centrifugal force. It is generally used for producing light or fine powders. A multi-stage cyclone is also available for specific requirements.

Bag filter collection method

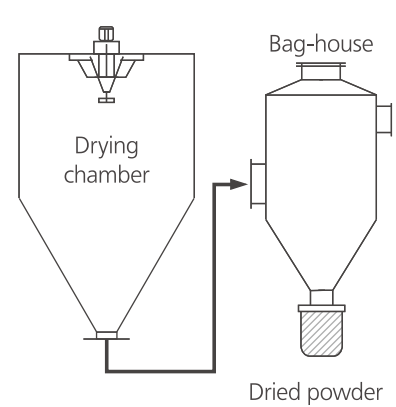

Fabric filters in the bag-house separate powders from the gas stream. It is suited for collecting extra fine particles where efficient collection cannot be achieved by a cyclone. A variety of filter materials including pre-coated filters can also be selected.

*Please contact us for further information, as there are other methods available.

Materials

As a standard feature, SUS(AISI)304 with buff #300 finishing is used in powder contacting part. Depending on the material characteristics, other materials, such as SUS (AISI) 316, SUS (AISI) 316L, fluoro-resin coating and higher buff finishing levels can be selected.

Heat sources

A variety of heat sources including electricity, steam, LNG, LPG, kerosene, heavy oil, exhaust heat sources within a factory, and a combination thereof can be selected. Depending on the cleanliness of the operation, the heat source can be selected from either a direct heating or indirect heating system. HEPA filters can also be selected. In case of indirect heating, a high level of energy saving can be achieved by circulating the exhaust heat of the heat exchanger.

Energy-saving system

By recycling the heat of exhaust gas that would normally be wasted, a high level of energy efficiency can be achieved. With our unique environmentally friendly system, not only the operating cost, but the CO₂ emissions can also be reduced.

R&D Lab spray dryer, Spray boy

Fit for your lab.

More than just a lab spray dryer. Flexible & easy.



More than lab-scale

Spray Boy is an ideal all-in-one spray dryer for R&D. It is designed for easy dismantlement and cleaning, and is capable of more high-level condition settings than general experimental spray dryers. Everything needed for operation including bag filters comes standard.

Integrated system

Spray boy is an integrated movable unit designed for easy set-up and relocation. Major components such as a touch screen, a liquid pump and a workbench are all equipped as standard. This integrated system allows an operator to control everything from one place.

A variety of options

A variety of options can be selected to meet your additional needs. Options include: closed-cycle system, HEPA filter, heat insulation unit, and fluororesin coating.



Model	SB39
Drying chamber diameter (mm)	φ387
Atomization mode	Two-fluid nozzle
Inlet gas temperature (°C)	max. 250
Water evaporation capacity (kg/h)	3
Heater capacity (kW)	5
Power	3-phase 200V 50Hz
Powder collection	Cyclone
Dust collection	Bag filter

*Water evaporation capacity is subject to change depending on inlet temperature, outlet temperature, gas flow, and an installed site conditions.

*The specifications and other information indicated in this publication may change without notice.

External dimensions

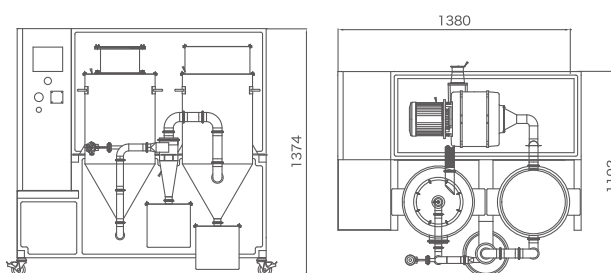

Small-scale spray dryer, R-Series

Best standard spray dryer.

Enables you to scale up your operation.



Designed to enable scaled up operations

Inlet and outlet fans come standard to control the internal pressure of the drying chamber, and allow for scaled up operating conditions in the future.

Visibility and operability

The R-Series spray dryer has a large inspection window to allow you to easily check operating conditions. It is also equipped with a large door for easy cleaning and maintenance.

Flexible design

All atomization modes can be selected with a variety of options. The R-Series can also be configured to operate both open-cycle and closed-cycle systems. A heat-resistant HEPA filter can be installed for high-purity materials.



Model	R80	R100	R120	R140	R160	R190
Drying chamber diameter (mm)	φ800	φ1000	φ1200	φ1400	φ1600	φ1900
External dimension W (mm)	1900	2100	2200	2400	2700	3400
External dimension D (mm)	2200	2300	2500	2900	3100	3500
External dimension H (mm)	1500	1600	1800	2200	2400	3400
Water evaporation capacity (kg/h)	4	5	8	14	22	28
Heater capacity (kW)	6	8	10	18	28	35

*The external dimensions include hot air generator, cyclone and bag house.

*Heater capacity is a calculated value based on an inlet temperature of 230°C and an outlet temperature of 80°C.

*Water evaporation capacity is subject to change depending on the atomization mode, inlet temperature, outlet temperature, gas flow, and the installation site conditions.

*The specifications and other information indicated in this publication may change without notice.

Turning spray dryer, TR-Series

Rotate & clean up.

Cleaning innovation you have never seen.



Easy cleaning

The drying chamber can be rotated 90 degrees to allow for easy cleaning, without the need for getting inside.

Ideal for R&D and small-scale production

TR-Series is the best solution for high-mix low-volume production and production of high-purity materials as well as R&D use.

Flexible design

All atomization modes can be selected with a variety of options. The TR-Series can also be configured to operate both open-cycle and closed-cycle systems. A heat-resistant HEPA filter can be installed for high-purity materials.



Model	TR80	TR100	TR120	TR140	TR160	TR190
Drying chamber diameter (mm)	φ800	φ1000	φ1200	φ1400	φ1600	φ1900
External dimension W (mm)	1900	1900	2300	2400	2500	5000
External dimension D (mm)	3200	3400	3600	4100	4400	5700
External dimension H (mm)	1800	2000	2200	2300	2500	3400
Water evaporation capacity (kg/h)	4	5	8	14	22	28
Heater capacity (kW)	6	8	10	18	28	35

*The external dimensions include the hot air generator, cyclone and bag house.

*Heater capacity is a calculated value based on an inlet temperature of 230°C and an outlet temperature of 80°C.

*Water evaporation capacity is subject to change depending on the atomization mode, inlet temperature, outlet temperature, gas flow, and the installation site conditions.

*The specifications and other information indicated in this publication may change without notice.

Pilot-scale spray dryer, P-Series

Small footprint, big capacity.

Detailed & customized design to get exactly the right process.



Advanced heat-recycling system

Our environmentally friendly heat-recycling system enables up to 25% energy savings. The specially designed exhaust heat circulation system reuses the heat of the exhaust gas with high efficiency.

Flexible design

All the atomization modes can be selected with a variety of options. The P-Series can also be configured to operate as both a spray cooler and spray dryer, as well as open-cycle and closed-cycle systems.



Model	P220	P240	P260	P290	P300
Drying chamber diameter (mm)	φ2200	φ2400	φ2600	φ2900	φ3000
External dimension W (mm)	3700	3900	4200	4500	4600
External dimension D (mm)	3900	4400	4900	6300	6500
External dimension H (mm)	3900	4400	4900	5500	5700
Water evaporation capacity (kg/h)	32	40	48	53	60
Heater capacity (kW)	40	50	60	68	80

*The external dimensions include hot air generator, cyclone and bag house.

*Heater capacity is a calculated value based on an inlet temperature of 230°C and an outlet temperature of 80°C.

*Water evaporation capacity is subject to change depending on the atomization mode, inlet temperature, outlet temperature, gas flow, and the installation site conditions.

*The specifications and other information indicated in this publication may change without notice.

Production-scale spray dryer, D-Series

Solutions for a competitive edge.

Designed for high yields with energy saving technology.



Technology & Experience

Through our experience of having installed spray dryers as large as 10 meters in drying chamber diameter (processing capacity of 24t/h), we provide the know-how of how to obtain a high yield while saving energy. We also offer automated systems such as a fully-automated operation system and CIP cleaning system.

Flexible design

All the atomization modes can be selected with a variety of options. D-Series can also be configured to operate as both a spray cooler and spray dryer.

Facility examples



Atomization mode: Rotary atomizer
Drying chamber diameter: $\phi 3400$ mm
Water evaporation capacity: 86 kg/h



Atomization mode: Rotary atomizer
Drying chamber diameter: $\phi 4000$ mm
Water evaporation capacity: 100 kg/h



Atomization mode: Rotary atomizer
Drying chamber diameter: $\phi 5000$ mm
Liquid material processing capacity: 500 kg/h



Atomization mode: Pressure nozzle
Drying chamber diameter: $\phi 4800$ mm
Water evaporation capacity: 1200 kg/h



Atomization mode: Rotary atomizer
Drying chamber diameter: $\phi 5000$ mm
Liquid material processing capacity: 350 kg/h



Atomization mode: Pressure nozzle
Drying chamber diameter: $\phi 4800$ mm
Water evaporation capacity: 1200 kg/h

Spray drying

Spray boy

R-Series

TR-Series

P-Series

D-Series

Spray cooler

Testing and
consignment processing

Rental service

Spray cooler

Spray cooling is a process where materials are taken from a melted state to a solid powder form. A spray cooler utilizes technology derived from spray dryers, where melted material is atomized and cooled down in an airstream to create spherical congealed powders with good fluidity.



Process design

A spray cooler utilizes technology derived from spray dryers. Therefore, the basic process flow such as atomization modes and product collection methods are all similar to that of spray dryers. Testing of a spray cooler can be arranged at our Powder Technical Center (PTC).

Process flow

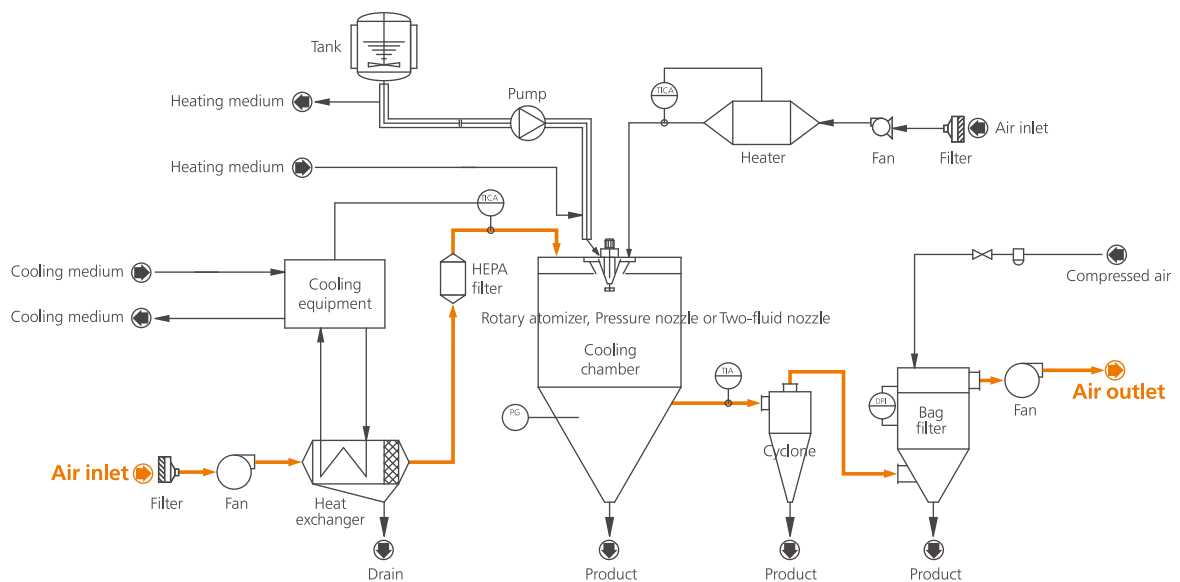

Testing and Consignment processing

From the early stages of R&D to large 24-hour-production planning as well as any concerns about your current production process, we offer high-value testing and consultation services with great know-how accumulated over many years. The Powder Technical Center (PTC) is located in Kanagawa prefecture, Japan, with a wide variety of spray dryers and analytical equipment. Our highly experienced and qualified testing engineers offer services with advanced process evaluations by measuring and analyzing the characteristics of your applications such as solid content, viscosity, moisture content, particle size distribution and particle formation. These evaluations are reflected in the testing process in real-time to achieve your specific requirements. We also offer a consignment processing service. The service is available in capacities of up to a few tons of liquid material per batch.

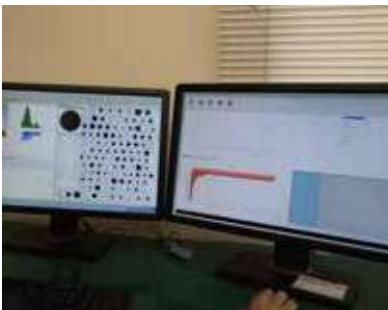
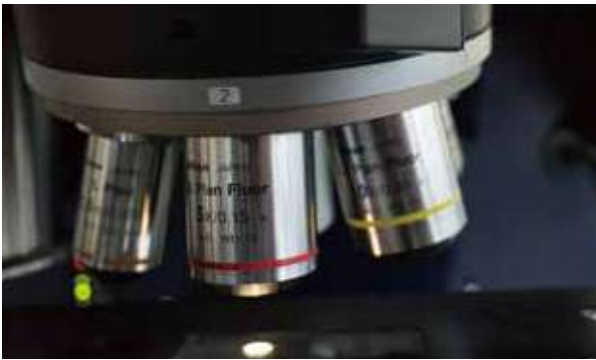

Do you have any requirements like this?

- ✓ Sample/trial powders are needed for my development of new materials
- ✓ Consignment production is required as we do not have the facility in-house
- ✓ Unable to purchase a new dryer as we are still at earlier phase
- ✓ Product samples are needed until our new facility starts operating
- ✓ We don't have the time and resources to gain production knowhow

Available facilities



Spray boy

Atomization mode: Two-fluid nozzle
Water evaporation capacity: up to 3 kg/h

Targeted particle size: a few micrometers to 30µm
System: Open-cycle system, Closed-cycle system



TR160

Atomization mode: Rotary atomizer, Two-fluid nozzle
Water evaporation capacity: up to 15 kg/h

Targeted particle size: a few micrometers to 80µm
System: Open-cycle system, Closed-cycle system



P260

Atomization mode: Rotary atomizer, Two-fluid nozzle, Pressure nozzle
Water evaporation capacity: up to 30 kg/h

Targeted particle size: a few micrometers to 120µm
System: Open-cycle system



D350

Atomization mode: Rotary atomizer, Two-fluid nozzle, Pressure nozzle
Water evaporation capacity: up to 50 kg/h

Targeted particle size: a few micrometers to 200µm
System: Open-cycle system

*Water evaporation capacity is subject to change depending on the operating conditions.

How to apply

We accept inquiries by telephone and email, and via our website. When making an inquiry, we request that you fill out our 'Testing/Consignment processing check sheet' in order to help us understand your requirements. The check sheet can be downloaded from our website.

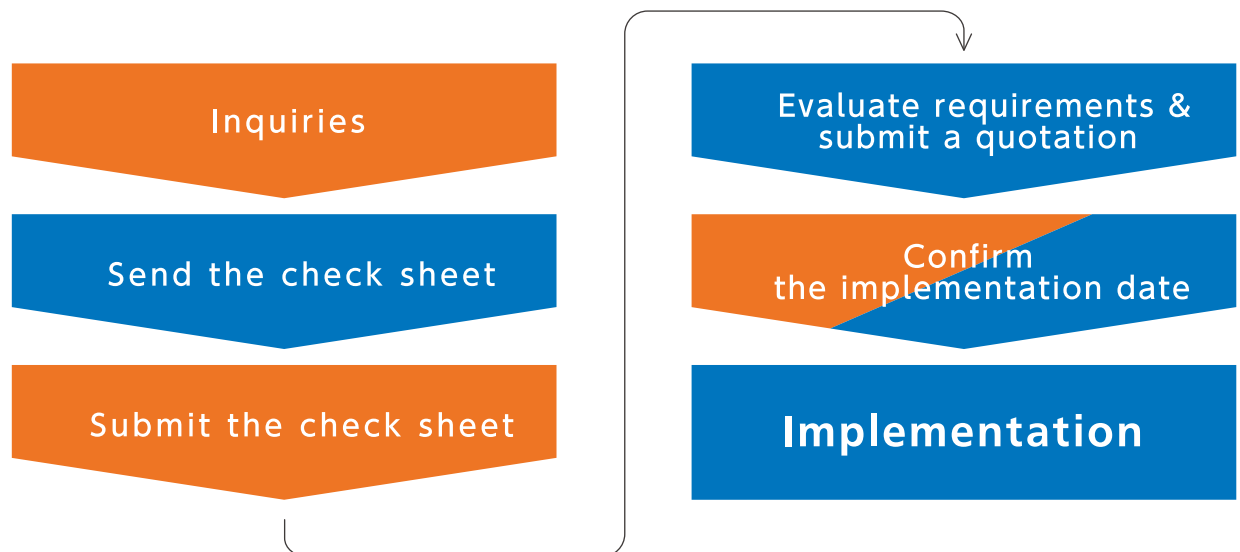

● ...Carried out by customers. ● ...Carried out by us.

Rental service

We started our official spray dryer rental service requested by our customers a few years ago. By taking this action, we have realized that the service is ideal for customers who want to try our spray dryer before purchase, or want to use one for only a certain period of time. During the rental period, we provide customer support service and consultation for your operating conditions.

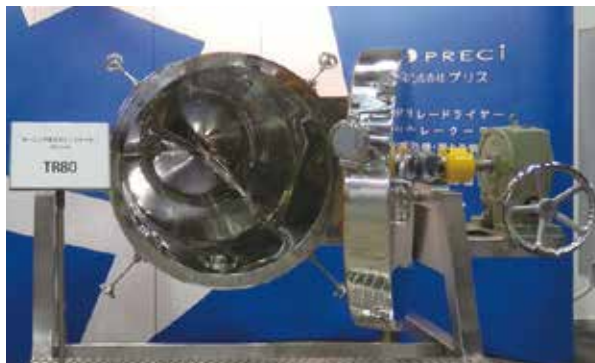

Ideal for the following customers

- We want to use the facility for a certain period only
- The facility will be no longer necessary once a project is completed
- Although our production is outsourced, we want to accumulate production knowhow
- We do not want to hold fixed assets
- Although our new material is confidential, we need consultation regarding our operations

Rental facilities

Model	Spray Boy	TR80	TR120
Atomization mode	Two-fluid nozzle	Two-fluid nozzle, Rotary atomizer	
Water evaporation capacity	up to 3kg/h	up to 4kg/h	up to 6kg/h
Targeted particle size	a few micrometers to 30 μ m	a few micrometers to 40 μ m	a few micrometers to 60 μ m
Monthly rental fee	(please contact us)		
System	Open-cycle System		

*Please contact us regarding the rental conditions and monthly fees.

*The monthly rental fee does not include transportation, installation and test run.

*The rental is for 6-monthly periods.

*The monthly rental fee does not include transportation for returning the facility at the end of the contract.

Official Sales Agent in Thailand

TSK

T.S.K. ENGINEERING CO., LTD.
6 Moo 5, Nongree, Muang,
Chonburi 20000 Thailand
Tel: +66 81 9785538
Email: contact@tskengineering.co.th
Website: www.tsengineering.co.th
Facebook: TSK Engineering
Line: @tskengineering



Spray dryer Spray cooler

www.preci.co.jp

Contact for inquiries

PRECi Co., Ltd.

Kawasaki office and Powder Technical Center

4-16-20 Kokan-dori, Kawasaki-ku, Kawasaki-shi, Kanagawa 210-0852 Japan
T +81-44-328-7665

Headquarters and Tokyo office

2-11-6 Taito, Taito-ku, Tokyo 110-0016 Japan
T +81-3-3839-4540

Precision Cleaning Test Center

1-1-23 Ryoke, Kawaguchi-shi, Saitama 332-0004 Japan

Kawaguchi office and Biotechnical Center

3-16-11 Iizuka, Kawaguchi-shi, Saitama 332-0023 Japan
T +81-48-258-5335